

Varenummer: 3901150080300
 Beskrivelse: Snekkegear med fri indgangsaksel
 VF 150V-80-HS

Mål

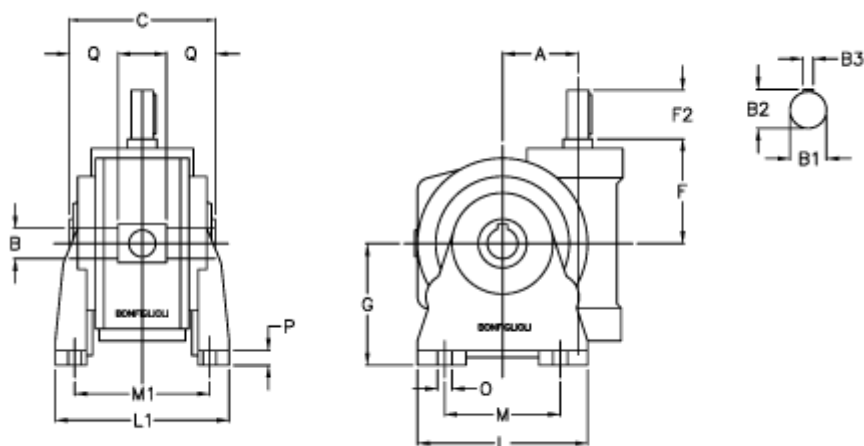

a	= 150.0	F2 = 65	Q = 55.0
B	= 50	g = 220	
B1	= 35	L = 330	
B2	= 38.0	L1 = 260	
B3	= 10	m = 240	
Betegnelse	= VF 150V-xx-HS	M1 = 211.0	
C	= 175	O = 18.0	
F	= 185.0	P = 20	